

# Technical data sheet

## Pressure ring, PG thread

Item number: 2027070

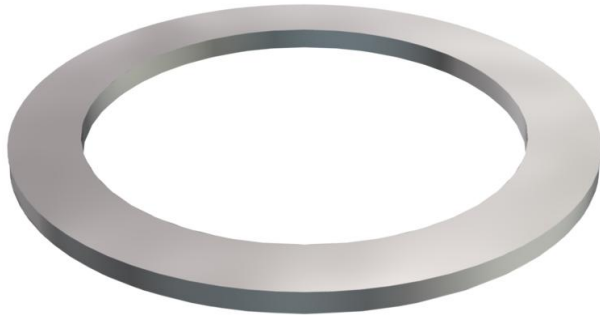

Pressure ring, Part 7, to DIN 46320, suitable for plastic and brass glands to DIN 46320.



**St** Steel

**GTP** Electrogalvanized, transparently passivated

### Master data

Item number	2027070
Type	107 D PG7 GTP
Description 1	Pressure ring
Manufacturer	OBO
Dimension	PG7
Material	Steel
Surface	Electrogalvanized, transparently passivated
Surface standard	
Smallest sales unit	100
Unit of quantity	Piece
Weight	0.025 kg
Weight unit	kg/100 pc.

### Dimensions

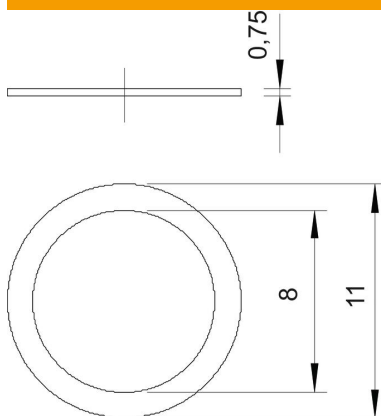

Dimension D1	11 mm
Dimension D2	8 mm

# Technical data sheet

Pressure ring, PG thread

Item number: 2027070



## Technical data

Version for	Miscellaneous
Screw for PG thread dimension	7
Inner diameter	8 mm