

# Technical data sheet

## Reduction, metric thread

Item number: 2030632

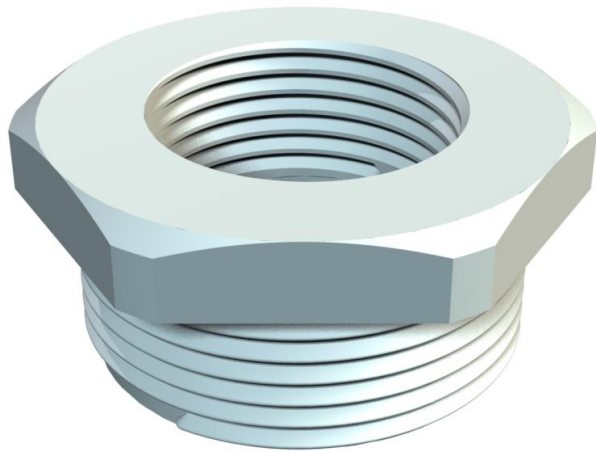

Reduction with metric internal and external thread for mounting plastic cable glands on enclosures. Protection class IP54 without additional connecting seal. Protection class up to IP68 possible with additional connecting seal, e.g. O-ring or flat sealing ring.



PA Polyamide

### Master data

Item number	2030632
Type	107 R M32-12 PA
Description 1	Reduction
Manufacturer	OBO
Dimension	M32-M12
Colour	Light grey; RAL 7035
Material	Polyamide
Smallest sales unit	50
Unit of quantity	Piece
Weight	1.2 kg
Weight unit	kg/100 pc.

# Technical data sheet

## Reduction, metric thread

Item number: 2030632



### Dimensions

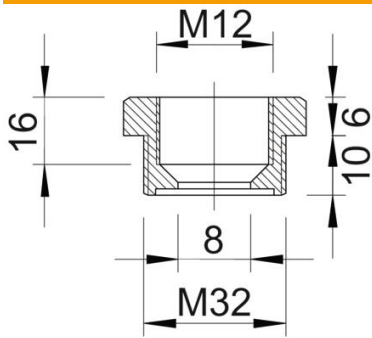

Dimension E	40 mm
Dimension L	16 mm
Dimension L1	10 mm
Dimension L2	6 mm
Dimension L3	16 mm

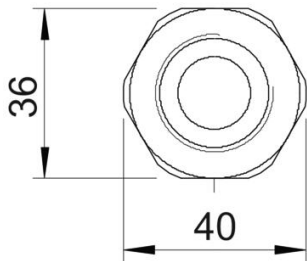

### Technical data

explosion-proof	no
Thread type: External thread	Metric
Thread type: Internal thread	Metric
Thread length	10 mm
Thread dimension, metric, external	32
Thread dimension, metric, internal	12
Halogen-free	yes
WAF	36
Nickel-plated	no