

Technical data sheet

Reduction, PG thread

Item number: 2030756

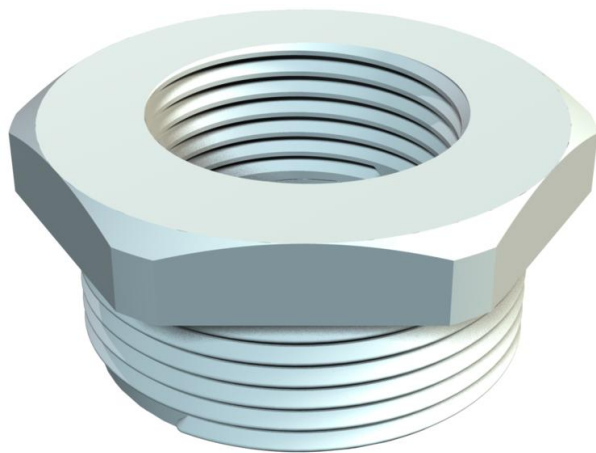

Reduction with PG internal and external thread to DIN 40430 for mounting plastic cable glands on enclosures. Protection class IP54 without additional connecting seal. Protection class up to IP68 possible with additional connecting seal, e.g. O-ring or flat sealing ring.



PA Polyamide

Master data

Item number	2030756
Type	107 R PG16-11 PA
Description 1	Reduction
Manufacturer	OBO
Dimension	PG16-PG11
Colour	Light grey; RAL 7035
Material	Polyamide
Smallest sales unit	50
Unit of quantity	Piece
Weight	0.48 kg
Weight unit	kg/100 pc.

Technical data sheet

Reduction, PG thread

Item number: 2030756



Dimensions

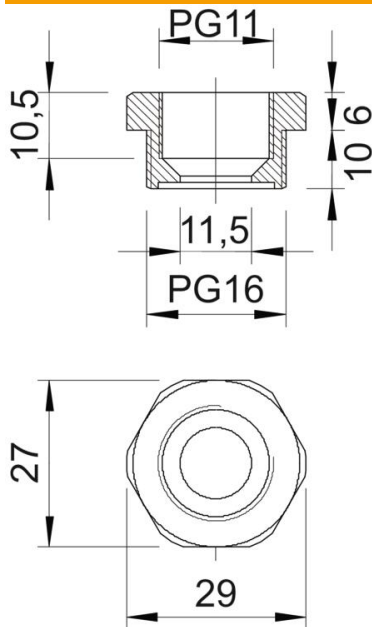

Dimension D	11.5 mm
Dimension E	29 mm
Dimension L1	10 mm
Dimension L2	6 mm
Dimension L3	10.5 mm

Technical data

explosion-proof	no
Thread type: External thread	PG
Thread type: Internal thread	PG
Thread length	10 mm
Thread dimension, PG, external	16
Thread dimension, PG, internal	11
Halogen-free	yes
WAF	27
Nickel-plated	no