

Technical data sheet

Reduction, PG thread

Item number: 2030802



Reduction with PG internal and external thread to DIN 40430 for mounting plastic cable glands on enclosures. Protection class IP54 without additional connecting seal. Protection class up to IP68 possible with additional connecting seal, e.g. O-ring or flat sealing ring.



PA Polyamide

Master data

Item number	2030802
Type	107 R PG29-21 PA
Description 1	Reduction
Manufacturer	OBO
Dimension	PG29-PG21
Colour	Light grey; RAL 7035
Material	Polyamide
Smallest sales unit	25
Unit of quantity	Piece
Weight	1.5 kg
Weight unit	kg/100 pc.

Technical data sheet

Reduction, PG thread

Item number: 2030802



Dimensions

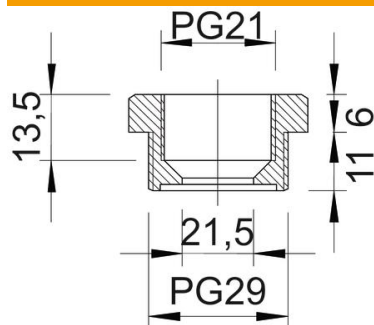

Dimension D	21.5 mm
Dimension E	40 mm
Dimension L1	11 mm
Dimension L2	6 mm
Dimension L3	13.5 mm

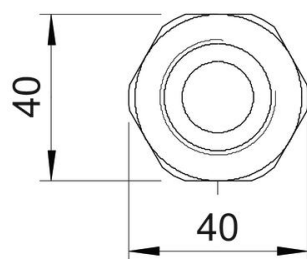

Technical data

explosion-proof	no
Thread type: External thread	PG
Thread type: Internal thread	PG
Thread length	11 mm
Thread dimension, PG, external	29
Thread dimension, PG, internal	21
Halogen-free	yes
WAF	39
Nickel-plated	no