

# Technical data sheet

## Dust protection plate, metric

Item number: 2028875



Cellular polyethylene.

Small protective disc to protect the V-TEC VM and V-TEC VM MS cable glands against dust before the cable is installed.

Application: the discs are pre-mounted between the cap nut and the seal. They do not need to be removed when the cable is installed, but are simply passed through to the interior with the cable.

Note: the discs do not provide any mechanical protection.



**ZELL  
PC** Zell - Polyethylen

### Master data

Item number	2028875
Type	107 S VTEC M20
Description 1	Dust protection plate
Description 2	for penetration
Manufacturer	OBO
Dimension	M20
Colour	Black
Material	Zell - Polyethylen
Smallest sales unit	100
Unit of quantity	Piece
Weight	0.01 kg
Weight unit	kg/100 pc.

### Dimensions

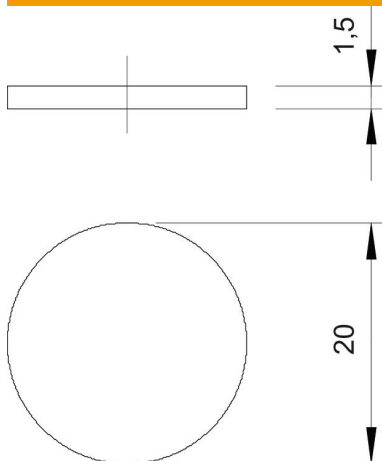

Dimension D	20 mm
Dimension t	1.5 mm

# Technical data sheet

Dust protection plate, metric

Item number: 2028875



## Technical data

Version for	Miscellaneous
Size	M20
Impact-resistant	no