

Technical data sheet

Locknut, PG thread, light grey

Item number: 2048485



Locknut DIN 46320, with PG thread DIN 40430.



PA Polyamide

Master data

Item number	2048485
Type	116 VDE PG48 PA
Description 1	Locknut
Manufacturer	OBO
Dimension	PG48
Colour	Light grey; RAL 7035
Material	Polyamide
Smallest sales unit	25
Unit of quantity	Piece
Weight	1.83 kg
Weight unit	kg/100 pc.

Technical data sheet

Locknut, PG thread, light grey

Item number: 2048485



Dimensions

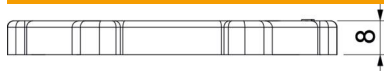

Dimension E	78 mm
Dimension L	8 mm

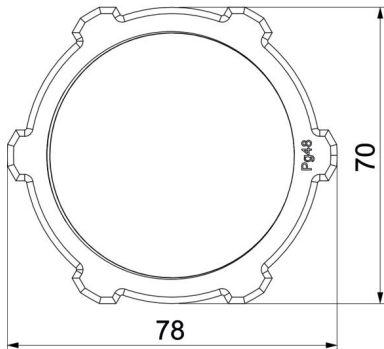

Technical data

Thread	Pg_48
Thread type	PG
Nominal thread size metric/PG	48
Fibre-glass reinforced	no
Halogen-free	yes
Impact-resistant	no
WAF	70