

Technical data sheet

Reduction, PG thread

Item number: 2089238

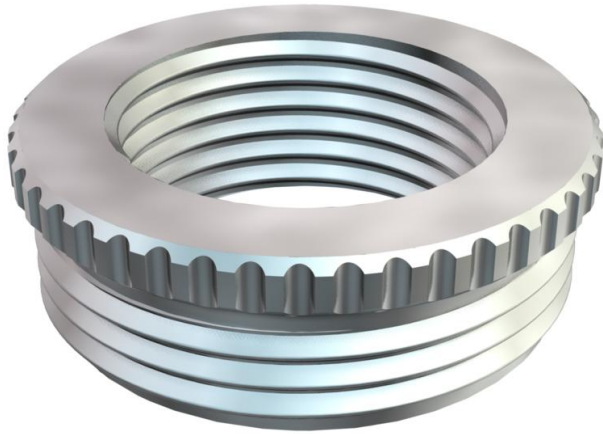

Reduction (Part H) to DIN 46320, with Pg thread to DIN 40430, as a transition from a PG thread hole to a smaller cable gland.

* Prices according to DEL notation.



CuZn
37 Brass

N Nickel-plated

Master data

Item number	2089238
Type	167 R MS PG21-11
Description 1	Reduction
Manufacturer	OBO
Dimension	PG21-PG11
Material	Brass
Surface	Nickel-plated
Surface standard	
Smallest sales unit	50
Unit of quantity	Piece
Weight	2.96 kg
Weight unit	kg/100 pc.

Technical data sheet

Reduction, PG thread

Item number: 2089238



Dimensions

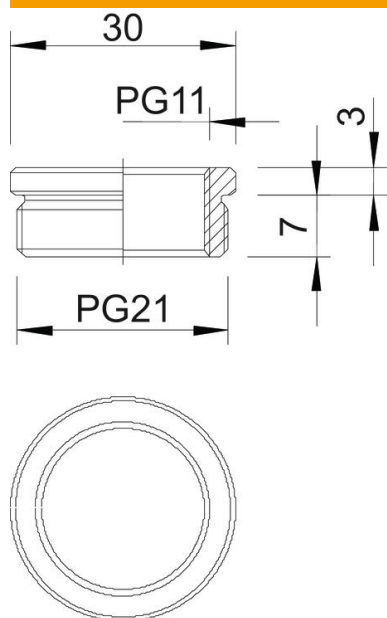

Dimension D	30 mm
Dimension L1	7 mm
Dimension L2	3 mm

Technical data

explosion-proof	no
Thread type: External thread	PG
Thread type: Internal thread	PG
Thread length	7 mm
Thread dimension, PG, external	21
Thread dimension, PG, internal	11
Nickel-plated	yes