

Technical data sheet

Locknut, metric thread with cutting teeth

Item number: 2091713



Locknuts DIN 46319 with metric thread IEC 423.

* Prices according to DEL notation.



CuZn
37 Brass

N Nickel-plated

Master data

Item number	2091713
Type	169 MSS M20
Description 1	Locknut
Description 2	with cutting teeth
Manufacturer	OBO
Dimension	M20x1,5
Material	Brass
Surface	Nickel-plated
Surface standard	
Smallest sales unit	50
Unit of quantity	Piece
Weight	0.76 kg
Weight unit	kg/100 pc.

Technical data sheet

Locknut, metric thread with cutting teeth

Item number: 2091713



Dimensions

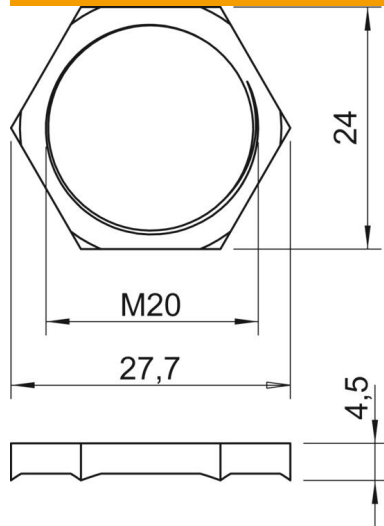

Dimension E	27.7 mm
Dimension L	4.5 mm

Technical data

Thread	M20_x_1,5
Thread type	Metric
Nominal thread size metric/PG	20
Fibre-glass reinforced	no
Halogen-free	no
Impact-resistant	no
WAF	24