

Technical data sheet

ISO nail clip 2008, pure white

Item number: 2225638



ISO nail clip, short design



PP Polypropylene

Master data

Item number	2225638
Type	2008 35 RW
Description 1	ISO nail clip
Manufacturer	OBO
Dimension	8mm, L35
Colour	Pure white; RAL 9010
Material	Polypropylene
Smallest sales unit	100
Unit of quantity	Piece
Weight	0.128 kg
Weight unit	kg/100 pc.

Technical data sheet

ISO nail clip 2008, pure white

Item number: 2225638



Dimensions

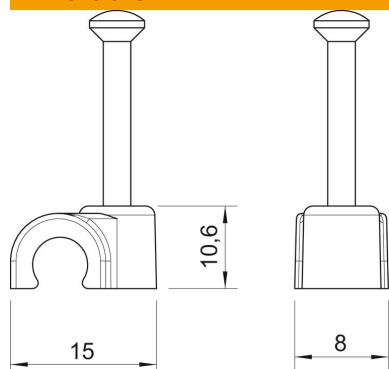

Dimension B	8 mm
Dimension H	10.6 mm
Dimension L	15 mm

Technical data

Double clip	no
Shape	Round (for round conductor)
for cable diameter	8 mm
For nail diameter	2,0x35
Hardened	yes
Halogen-free	yes
With nail	yes
Nail length	35 mm
Impact-resistant	no
Pipe locking	no