

Technical data sheet

Adhesive clip 2025, light grey

Item number: 2232901



Adhesive clip, for clamping to the cable.



PP

Polypropylene

Master data

Item number	2232901
Type	2025 25 LGR SO
Description 1	Self-retaining clip
Manufacturer	OBO
Dimension	4-7mm, L25
Colour	Light grey; RAL 7035
Material	Polypropylene
Smallest sales unit	300
Unit of quantity	Piece
Weight	0.086 kg
Weight unit	kg/100 pc.

Technical data sheet

Adhesive clip 2025, light grey

Item number: 2232901



Dimensions

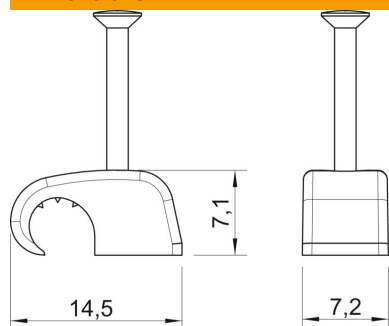

Dimension B	7.2 mm
Dimension H	7.1 mm
Dimension L	14.5 mm

Technical data

Double clip	no
Shape	Round (for round conductor)
for cable diameter, max.	7 mm
for cable diameter, min.	4 mm
For nail diameter	2 x 25
Hardened	yes
Halogen-free	yes
With nail	yes
Nail length	25 mm
Impact-resistant	yes
Pipe locking	no