

# Technical data sheet

## Counter-trough, metal, universal A2

Item number: 1197231



Metal counter-trough, for mounting on clamp clip. Can be used universally, irrespective of the rail.



**A2** Stainless steel

**2B** Bright, treated

### Master data

Item number	1197231
Type	2058FW M 22 A2
Description 1	Counter-trough
Manufacturer	OBO
Dimension	16-22mm
Material	Stainless steel
Surface	Bright, treated
Surface standard	
Smallest sales unit	100
Unit of quantity	Piece
Weight	1.062 kg
Weight unit	kg/100 pc.

# Technical data sheet

## Counter-trough, metal, universal A2

Item number: 1197231



### Dimensions



Dimension B	28 mm
Dimension H	8.8 mm
Dimension L	35 mm

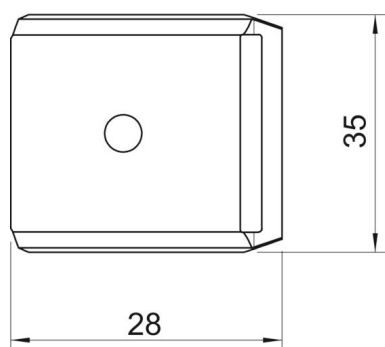

### Technical data

Counter-trough/clip version	Counter sleeve
Suitable for max. cable diameter	22 mm
Halogen-free	yes
Clamping range D, max.	22 mm
Clamping range D, min.	16 mm