

Technical data sheet

Double trough, metal DD

Item number: 1199722



Metallic double trough as intermediate layer between two or three cables within a clamp clip.



St Steel

DD Strip galvanised zinc/aluminium, Double Dip

Master data

Item number	1199722
Type	2058 M2 22 DD
Description 1	Double trough
Manufacturer	OBO
Dimension	16-22mm
Material	Steel
Surface	Strip galvanised zinc/aluminium, Double Dip
Surface standard	DIN EN 10346
Smallest sales unit	50
Unit of quantity	Piece
Weight	2.3 kg
Weight unit	kg/100 pc.

Technical data sheet

Double trough, metal DD

Item number: 1199722



Dimensions

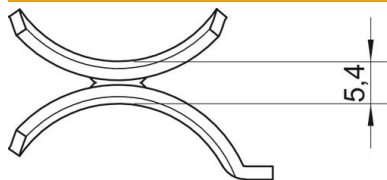

Dimension B	28 mm
Dimension H	5.4 mm
Dimension L	35 mm

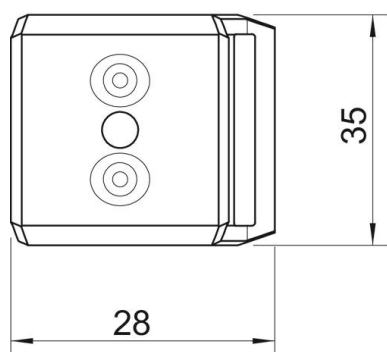

Technical data

Counter-trough/clip version	Double trough
Suitable for max. cable diameter	22 mm
Clamping range D, max.	22 mm
Clamping range D, min.	16 mm