

Technical data sheet

Double trough, metal DD

Item number: 1199730



Metallic double trough as intermediate layer between two or three cables within a clamp clip.



St Steel

DD Strip galvanised zinc/aluminium, Double Dip

Master data

Item number	1199730
Type	2058 M2 28 DD
Description 1	Double trough
Manufacturer	OBO
Dimension	22-28mm
Material	Steel
Surface	Strip galvanised zinc/aluminium, Double Dip
Surface standard	DIN EN 10346
Smallest sales unit	50
Unit of quantity	Piece
Weight	3.1 kg
Weight unit	kg/100 pc.

Technical data sheet

Double trough, metal DD

Item number: 1199730



Dimensions



Dimension B	34 mm
Dimension H	5.4 mm
Dimension L	35 mm

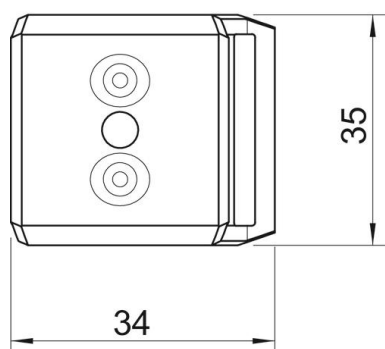

Technical data

Counter-trough/clip version	Double trough
Suitable for max. cable diameter	28 mm
Clamping range D, max.	28 mm
Clamping range D, min.	22 mm