

Technical data sheet

Hat profile rail 35 x 7.5 mm

Item number: 1115386



Hat profile rail 35 x 7.5 mm to DIN EN 60715 (formerly DIN EN 50022).



St Steel

FS Strip galvanized

Master data

Item number	1115386
Type	2069 T250 FS
Description 1	Top hat rail
Description 2	in extra lengths for T series
Manufacturer	OBO
Dimension	206x35x7,5
Material	Steel
Surface	Strip galvanized
Surface standard	DIN EN 10346
Smallest sales unit	10
Unit of quantity	Piece
Weight	7.107 kg
Weight unit	kg/100 pc.

Technical data sheet

Hat profile rail 35 x 7.5 mm

Item number: 1115386



Dimensions

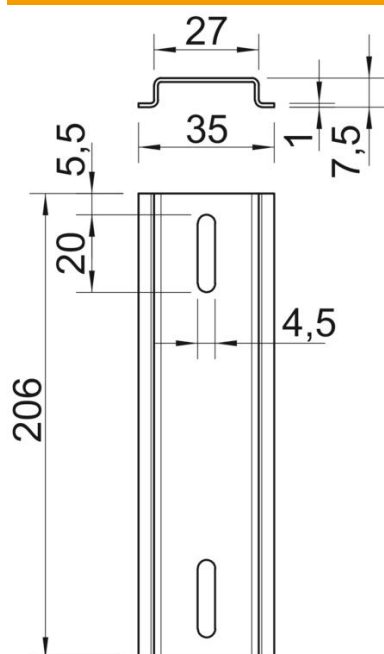

Length	206 mm
Width	35 mm
Height	7.5 mm

Technical data

Version for	For T 250 lengthwise
Version, rails	Support rail DIN EN 60715
Hole shape (ETIM)	Long slot
Material thickness	1 mm