

# Technical data sheet

## Screw-in spacer clip, universal

Item number: 1380427



With M6 thread.  
Universal clip with large tensioning area.

- St** Steel
- G** Electrogalvanized

### Master data

Item number	1380427
Type	2072 M6 G
Description 1	Distance saddle
Description 2	with threaded connection M6
Manufacturer	OBO
Dimension	30-44mm
Material	Steel
Surface	Electrogalvanized
Surface standard	EN ISO 19598 / EN ISO 4042
Smallest sales unit	25
Unit of quantity	Piece
Weight	5.99 kg
Weight unit	kg/100 pc.

# Technical data sheet

## Screw-in spacer clip, universal

Item number: 1380427



### Dimensions

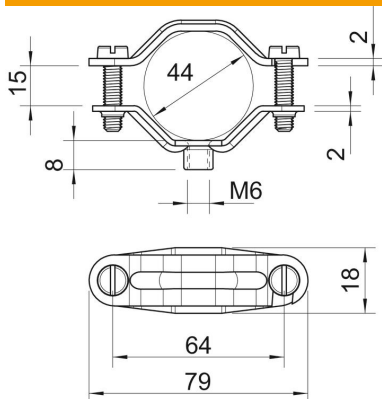

Length	79 mm
Width	16 mm
Dimension A	79 mm
Dimension B	64 mm
Dimension b	18 mm
Dimension D	44 mm
Dimension d min.	44 mm
Dimension H	8 mm
Dimension L	79 mm
Dimension t1 (mm)	2
Dimension t2 (mm)	2
Dimension x	15 mm

### Technical data

Version for	Closed
Fastening type	Screw hole
Suitable in fire protection area	no
Halogen-free	no
Plastic-covered	no
Hole size	M6 mm
Material thickness	2 mm
Bolt	M5 x 22
Clamping range D, max.	44 mm
Clamping range D, min.	30 mm
UV-resistant	yes