

Technical data sheet

Quick clip, flame-resistant, pure white

Item number: 2149363



Flame-resistant, flush-mounted clip to accept metric steel armoured pipes and heavy-duty insulating pipes, as well as Quick Pipe electrical installation pipes. Universal fastening options on walls and ceilings, both in indoor and protected outdoor areas. With slot for side alignment during mounting with wood screw or knock-in anchor. Toolless pipe mounting. Can also be arranged with OBO Multi-Quick or starQuick clip. M16 - M32 size can be screwed onto M6 thread. Recommended fastening spacing 50–60 cm, for max. extraction values F at a room temperature of 20 °C, see the table.



PP Polypropylene

Master data

Item number	2149363
Type	2955 F M25 RW
Description 1	Quick clip
Description 2	flame-resistant
Manufacturer	OBO
Dimension	M25
Colour	Pure white; RAL 9010
Material	Polypropylene
Smallest sales unit	100
Unit of quantity	Piece
Weight	0.43 kg
Weight unit	kg/100 pc.

Technical data sheet

Quick clip, flame-resistant, pure white

Item number: 2149363



Dimensions

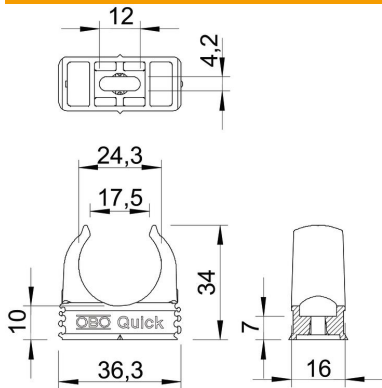

Dimension A	36.3 mm
Dimension B	16 mm
Dimension C	17,5 mm
Dimension D	24.3 mm
Dimension E	12 mm
Dimension F	4.2 mm
Dimension h	10 mm
Dimension H	34 mm

Technical data

Expandable	yes
Number of cables/pipes	1
Pull-out value	90 N
Fastening type	Screw hole
Flame-resistant	Acc. to VDE 0471/DIN 695 Part 2-1, test temperature 750°C
Closed	no
Halogen-free	yes
With inlay	no
Nominal size/text	M25
Quick clip installation	Durchgangsloch,_auf_M6_Gewinde_aufschraubbar
Clamping range D, max.	25 mm
Clamping range D, min.	25 mm
UV-resistant	no