

Technical data sheet

ISO base clip

Item number: 2130289



ISO base clip 25.5–28 mm



PS Polystyrene

Master data

Item number	2130289
Type	2960 28 M6 LGR
Description 1	ISO base clip
Manufacturer	OBO
Dimension	25,5-28mm
Colour	Light grey; RAL 7035
Material	Polystyrene
Smallest sales unit	25
Unit of quantity	Piece
Weight	1.341 kg
Weight unit	kg/100 pc.

Technical data sheet

ISO base clip

Item number: 2130289



Dimensions

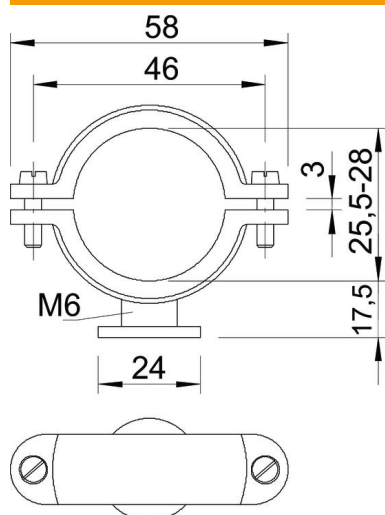

Dimension A	58 mm
Dimension B	46 mm
Dimension d	24 mm
Dimension H	17.5 mm
Dimension x	3 mm

Technical data

Number of cables/pipes	1
Version for	Closed
Fastening type	Screw hole
Suitable in fire protection area	no
Thread	M6
Size	Pg 9
Halogen-free	yes
Plastic-covered	no
Bolt	M5 x 14
Clamping range D, max.	28 mm
Clamping range D, min.	25.5 mm
UV-resistant	no