

# Technical data sheet

## ISO base clip

Item number: 2130351



ISO base clip 31.5–35 mm



**PS** Polystyrene

### Master data

Item number	2130351
Type	2960 35 M6 LGR
Description 1	ISO base clip
Manufacturer	OBO
Dimension	31,5-35mm
Colour	Light grey; RAL 7035
Material	Polystyrene
Smallest sales unit	25
Unit of quantity	Piece
Weight	1.761 kg
Weight unit	kg/100 pc.

# Technical data sheet

## ISO base clip

Item number: 2130351



### Dimensions

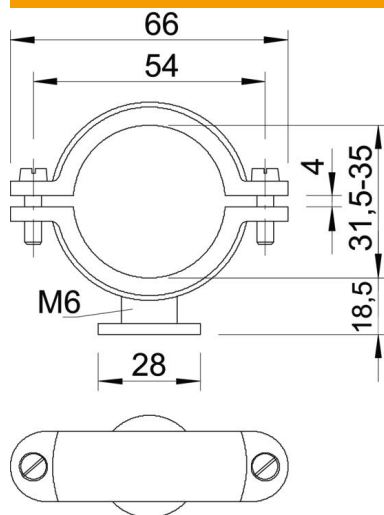

Dimension A	66 mm
Dimension B	54 mm
Dimension d	28 mm
Dimension H	18.5 mm
Dimension x	4 mm

### Technical data

Number of cables/pipes	1
Version for	Closed
Fastening type	Screw hole
Suitable in fire protection area	no
Thread	M6
Size	Pg 9
Halogen-free	yes
Plastic-covered	no
Bolt	M5 x 14
Clamping range D, max.	35 mm
Clamping range D, min.	31.5 mm
UV-resistant	no