

# Technical data sheet

## ISO base clip

Item number: 2130432



ISO base clip 40.5–43 mm



**PS** Polystyrene

### Master data

Item number	2130432
Type	2960 43 M6 LGR
Description 1	ISO base clip
Manufacturer	OBO
Dimension	40,5-43mm
Colour	Light grey; RAL 7035
Material	Polystyrene
Smallest sales unit	20
Unit of quantity	Piece
Weight	3.098 kg
Weight unit	kg/100 pc.

# Technical data sheet

## ISO base clip

Item number: 2130432



### Dimensions

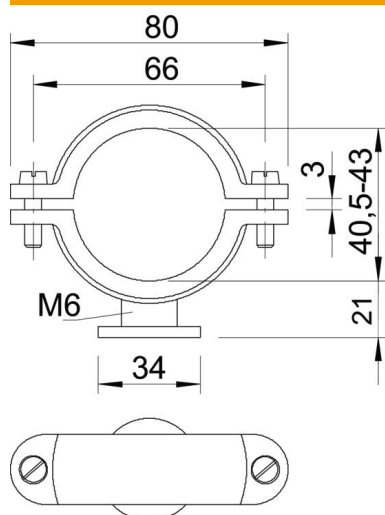

Dimension A	80 mm
Dimension B	66 mm
Dimension d	34 mm
Dimension H	21 mm
Dimension x	3 mm

### Technical data

Number of cables/pipes	1
Version for	Closed
Fastening type	Screw hole
Suitable in fire protection area	no
Thread	M6
Size	Pg 9
Halogen-free	yes
Plastic-covered	no
Bolt	M5 x 18
Clamping range D, max.	43 mm
Clamping range D, min.	40.5 mm
UV-resistant	no