

Technical data sheet

Grip ISO clip, double

Item number: 2107015

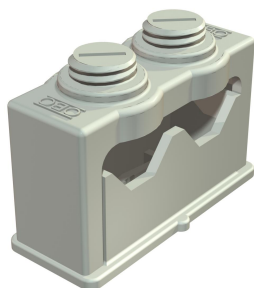

Solid cable fastening through clamping screws, with adhesive base, slot and for screwing to M6 thread.

Use the Impu-Fix ribbon conductor quick adhesive, type 509, to stick the polystyrene clips to masonry and concrete.



PS Polystyrene

Master data

Item number	2107015
Type	3040 2
Description 1	Grip ISO clip
Description 2	for 2 cables
Manufacturer	OBO
Dimension	6-16mm
Colour	Light grey; RAL 7035
Material	Polystyrene
Smallest sales unit	25
Unit of quantity	Piece
Weight	1.184 kg
Weight unit	kg/100 pc.

Technical data sheet

Grip ISO clip, double

Item number: 2107015



Dimensions

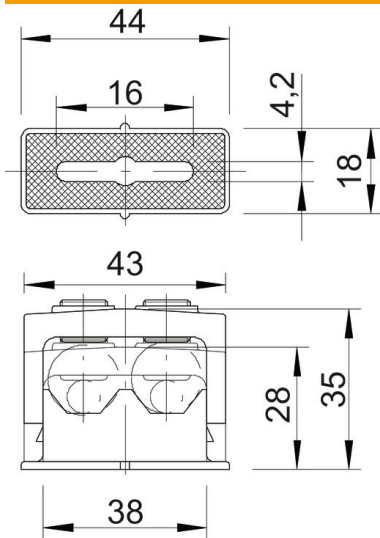

Dimension a	44 mm
Dimension a1 (mm)	16 mm
Dimension b	18 mm
Dimension b1	4.2 mm
Dimension c	43 mm
Dimension d	28 mm
Dimension e	35 mm
Dimension f	38 mm

Technical data

Expandable	no
Number of cables/pipes	2
Fastening type	Screw hole
Halogen-free	yes
Snap system	yes
Impact-resistant	yes
Clamping range D, max.	16 mm
Clamping range D, min.	6 mm