

Technical data sheet

Sprint screw, with Torx

Item number: 3198268



Hardened steel, electrogalvanised and Hostaflon-coated. Countersunk head with T bit (six lobe head), sizes Ø 3 mm T10, Ø 3.5 mm T15, Ø 4 and 4.5 mm T20, Ø 5 mm T25.

The use of Sprint screws leads to considerably reduced screw-in times compared with standard screws. This noticeable advantage comes from the point with the first thread, which leads on to the double thread beyond.

Areas of use: wood, chipboard, Rigips panels, plastic anchors.



St Steel

G Electrogalvanized

Master data

Item number	3198268
Type	4759T 4.5x50
Description 1	Sprint screw
Description 2	countersunk head, T-drive
Manufacturer	OBO
Dimension	4,5x50mm
Material	Steel
Surface	Electrogalvanized
Surface standard	EN ISO 19598 / EN ISO 4042
Smallest sales unit	200
Unit of quantity	Piece
Weight	0.34 kg
Weight unit	kg/100 pc.

Technical data sheet

Sprint screw, with Torx

Item number: 3198268



Dimensions

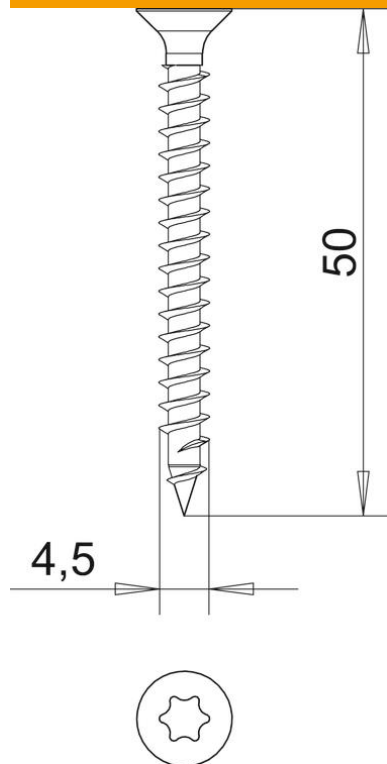

Length	50 mm
Dimension D	4.5 mm
Dimension L	50 mm

Technical data

Hardened	yes
Head diameter	8.2 mm
Head shape	Countersunk head
Screw system	Torx