

# Technical data sheet

## Fastening clip 605, medium duty, G

Item number: 1018256



Two lobe fastening clips for cables and pipes.

\* Sizes 7 to 12 not suitable for bolt-firing tool.



**St** Steel

**G** Electrogalvanized

### Master data

Item number	1018256
Type	605 25 G
Description 1	Fastening clip
Description 2	two lobe
Manufacturer	OBO
Dimension	25mm
Material	Steel
Surface	Electrogalvanized
Surface standard	EN ISO 19598 / EN ISO 4042
Smallest sales unit	100
Unit of quantity	Piece
Weight	0.96 kg
Weight unit	kg/100 pc.

# Technical data sheet

## Fastening clip 605, medium duty, G

Item number: 1018256



### Dimensions

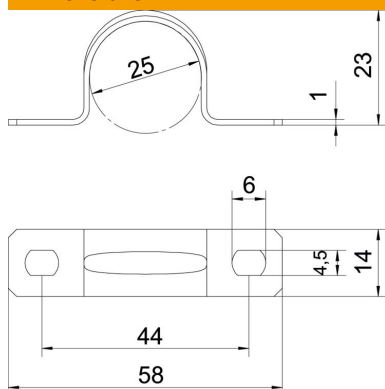

Length	58 mm
Width	14 mm
Height	23 mm
Dimension A	58 mm
Dimension B	44 mm
Dimension b	14 mm
Dimension D	25 mm
Dimension d	4.5 mm
Dimension e	6 mm
Dimension H	23 mm
Dimension t	1 mm

### Technical data

Distance to the wall	no
Number of cables/pipes	1
Version for	Two-lobe
Fastening type	Screw hole
For diameter	25
Suitable in fire protection area	no
Halogen-free	yes
Plastic-covered	no
Hole size	4,5 x 6 mm
Material thickness	1 mm
Nominal diameter	25 mm
UV-resistant	yes