

Technical data sheet

Fastening clip 605, medium duty, G

Item number: 1018604



Two lobe fastening clips for cables and pipes.

* Sizes 7 to 12 not suitable for bolt-firing tool.



St Steel

G Electrogalvanized

Master data

Item number	1018604
Type	605 60 G
Description 1	Fastening clip
Description 2	two lobe
Manufacturer	OBO
Dimension	60mm
Material	Steel
Surface	Electrogalvanized
Surface standard	EN ISO 19598 / EN ISO 4042
Smallest sales unit	25
Unit of quantity	Piece
Weight	3.8 kg
Weight unit	kg/100 pc.

Technical data sheet

Fastening clip 605, medium duty, G

Item number: 1018604



Dimensions

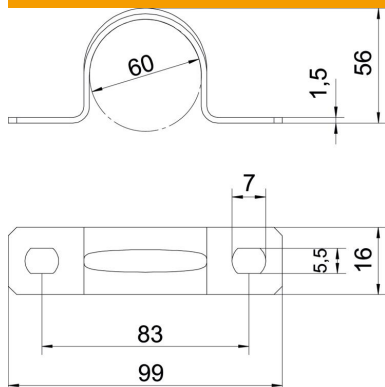

Length	99 mm
Width	16 mm
Height	56 mm
Dimension A	99 mm
Dimension B	83 mm
Dimension b	16 mm
Dimension D	60 mm
Dimension d	5.5 mm
Dimension e	7 mm
Dimension H	56 mm
Dimension t	1.5 mm

Technical data

Distance to the wall	no
Number of cables/pipes	1
Version for	Two-lobe
Fastening type	Screw hole
For diameter	60
Suitable in fire protection area	no
Halogen-free	yes
Plastic-covered	no
Hole size	5,5 x 7 mm
Material thickness	1.5 mm
Nominal diameter	60 mm
UV-resistant	yes