

Technical data sheet

Screw-in spacer clip

Item number: 1366254

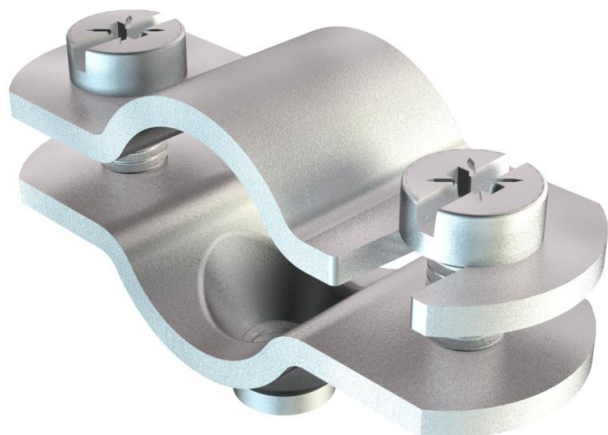

With M6 thread.



St Steel

G Electrogalvanized

Master data

Item number	1366254
Type	731 W 25 G
Description 1	Distance saddle
Description 2	with threaded connection M6
Manufacturer	OBO
Dimension	20-25mm
Material	Steel
Surface	Electrogalvanized
Surface standard	EN ISO 19598 / EN ISO 4042
Smallest sales unit	50
Unit of quantity	Piece
Weight	3.48 kg
Weight unit	kg/100 pc.

Technical data sheet

Screw-in spacer clip

Item number: 1366254



Dimensions

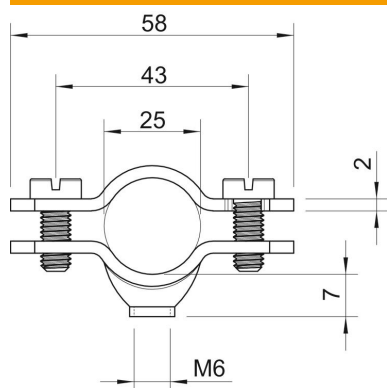

Length	58 mm
Dimension A	58 mm
Dimension B	43 mm
Dimension D	25 mm
Dimension d min.	25 mm
Dimension t	2 mm

Technical data

Number of cables/pipes	1
Version for	Closed
Fastening type	Screw hole
Suitable in fire protection area	no
Halogen-free	no
Plastic-covered	no
Hole size	M6 mm
Material thickness	2 mm
Bolt	M5 x 14
Clamping range D, max.	25 mm
Clamping range D, min.	20 mm
UV-resistant	yes