

Technical data sheet

Screw-in nipple, PG thread, with perforation membrane

Item number: 2032511

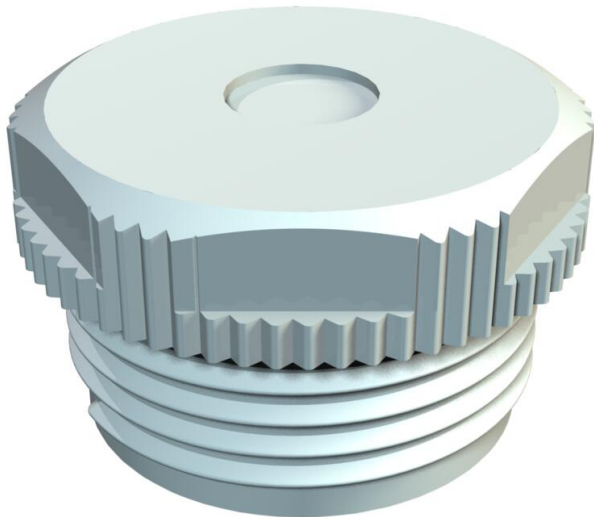

With perforation membrane, the opening D is pre-marked, but closed.

Grip seal to screw into PG thread to DIN 40430.

With self-sealing cone at the end of the thread, therefore no connection thread sealing ring required. Protection rating achievable with careful mounting: IP54. With perforation membranes, the opening D is pre-marked, but closed.



PE Polyethylene

Master data

Item number	2032511
Type	90 PG11 DSMB
Description 1	Screw-in nipple
Description 2	with puncture membrane
Manufacturer	OBO
Dimension	PG11
Colour	Light grey; RAL 7035
Material	Polyethylene
Smallest sales unit	100
Unit of quantity	Piece
Weight	0.156 kg
Weight unit	kg/100 pc.

Technical data sheet

Screw-in nipple, PG thread, with perforation membrane



Item number: 2032511

Dimensions

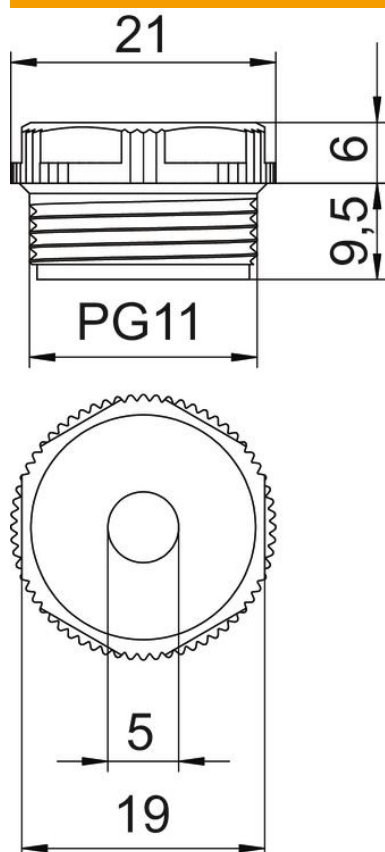

Dimension D	5 mm
Dimension E	21 mm
Dimension L1	9.5 mm
Dimension L2	6 mm

Technical data

Thread length	9.5 mm
Size	Pg 11
Halogen-free	yes
WAF	19
Protection rating	IP54