

Technical data sheet

Ceiling hook

Item number: 3450090



Ceiling hook with rolled wood screw thread.



St Steel

G Electrogalvanized

Master data

Item number	3450090
Type	915 3.9x90 G
Description 1	Ceiling hook
Description 2	with wood screw thread
Manufacturer	OBO
Dimension	3,9x90mm
Material	Steel
Surface	Electrogalvanized
Surface standard	EN ISO 19598 / EN ISO 4042
Smallest sales unit	100
Unit of quantity	Piece
Weight	1.076 kg
Weight unit	kg/100 pc.

Technical data sheet

Ceiling hook

Item number: 3450090



Dimensions

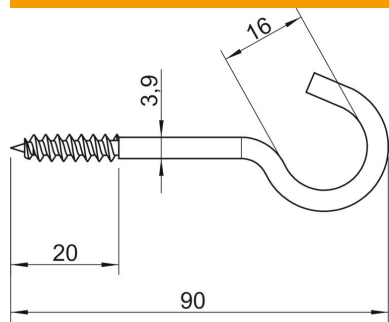

Length	90 mm
Dimension L	90 mm
Dimension L1	20 mm

Technical data

Breaking load	0.15 kN
Thread length	20 mm
hook diameter	16 mm
Plastic-covered	no
Material diameter	3.9 mm