

Technical data sheet

Tension jack A4

Item number: 5300127



With hook and eye, to DIN 1480.



A4 Stainless steel

2B Bright, treated

Master data

Item number	5300127
Type	945 M12 A4
Description 1	Tensioner
Manufacturer	OBO
Dimension	M12
Material	Stainless steel
Surface	Bright, treated
Surface standard	
Smallest sales unit	5
Unit of quantity	Piece
Weight	42 kg
Weight unit	kg/100 pc.

Technical data sheet

Tension jack A4

Item number: 5300127



Dimensions

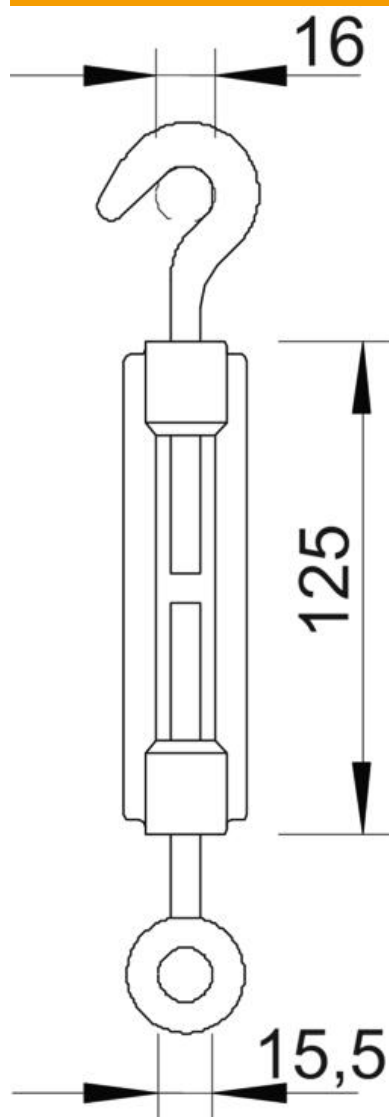

Dimension A	16 mm
Dimension B	15.5 mm
Dimension C	125 mm

Technical data

Breaking load	8 kN
Thread	M12
Length of clamping nut C	125 mm
Span width	85 mm