

Technical data sheet

Hammer-head bolt A4

Item number: 1148080



Hammer-head bolt for use with CM3015, CM3518 and AM3518 profile rails



A4 Stainless steel

2B Bright, treated

Master data

Item number	1148080
Type	ACMHB M8x30 A4
Description 1	Hammerhead screw
Description 2	for profile rails, medium
Manufacturer	OBO
Dimension	M8x30mm
Material	Stainless steel
Surface	Bright, treated
Surface standard	
Smallest sales unit	50
Unit of quantity	Piece
Weight	3.45 kg
Weight unit	kg/100 pc.

Technical data sheet

Hammer-head bolt A4

Item number: 1148080



Dimensions

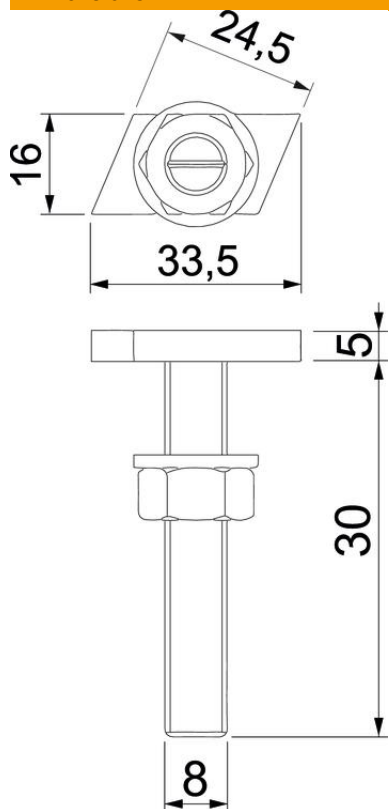

Length	33.5 mm
Width	16 mm
Height	5 mm
Dimension L	30 mm

Technical data

Suitable for mounting rail	yes
Thread	M 8 x 30mm
Thread metric	8