

Technical data sheet

Wall and support bracket AW 30 A2

Item number: 6442870



Medium-duty wall and support bracket with welded head plate.
Fastening of the bracket to the U support of width 400 mm or greater using a hexagonal bolt through both sides of the support. Please insert suitable spacers.



A2 Stainless steel

2B Bright, treated

Master data

Item number	6442870
Type	AW 30 41 A2
Description 1	Wall and support bracket
Description 2	with welded head plate
Manufacturer	OBO
Dimension	B410mm
Material	Stainless steel
Surface	Bright, treated
Surface standard	
Smallest sales unit	1
Unit of quantity	Piece
Weight	85.2 kg
Weight unit	kg/100 pc.

Technical data sheet

Wall and support bracket AW 30 A2



Item number: 6442870

Dimensions

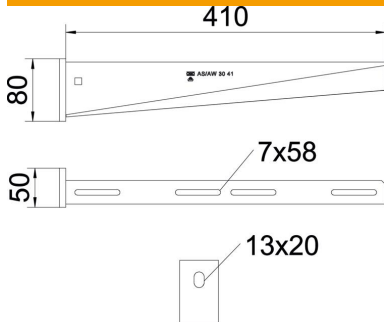

Length	50 mm
Width	410 mm
Height	80 mm
Dimension A	50 mm
Dimension B	410 mm
Dimension H	80 mm

Technical data

Version for	Wall and support bracket
F in kN	3 kN
Maintain electrical functions	no
Hole diameter	13 mm
Rustproof steel, pickled	yes
Angle range, max.	90 mm
Angle range, min.	90 mm

Loads

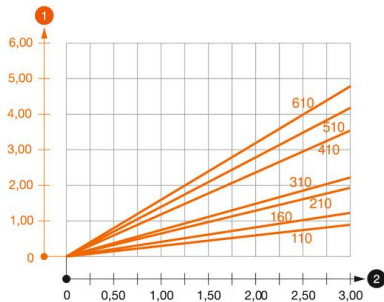

Load diagram, bracket, type AW 30

- 1** Bending of the bracket tip at permitted bracket load
- 2** Permitted bracket load in kN without man load
- Load curve with bracket lengths in mm

Characteristic anchor load values for wall and support bracket AW 30

Anchor type	Wall fastening								
	Max. load [kN]								
	Bracket width [mm]								
	110	160	210	310	410	510	560	610	710
BZ3 10x90/0-30	3.00	2.10	-	-	-	-	-	-	-
BZ3 12x110/0-35	-	-	3.00	2.71	2.07	2.02	1.98	1.98	1.51

Die angegebenen Werte basieren auf ungerissenen Beton der Festigkeitsklasse C20/25. Die Einbaubedingungen der ETA-Zulassung (Dübel) sind zu beachten!