

# Technical data sheet

## Wall bracket AW 80

Item number: 6417795



Heavy-duty wall bracket with welded head plate.  
When fastening cable trays and ladders with truss-head bolts of size M6, please order large washers separately (perforation in bracket 9 x ...).



**St** Steel

**FT** Hot-dip galvanised

### Master data

Item number	6417795
Type	AW 80 41 FT
Description 1	Wall bracket
Description 2	with welded head plate
Manufacturer	OBO
Dimension	B410mm
Material	Steel
Surface	Hot-dip galvanised
Surface standard	DIN EN ISO 1461
Smallest sales unit	1
Unit of quantity	Piece
Weight	213 kg
Weight unit	kg/100 pc.

# Technical data sheet

## Wall bracket AW 80

Item number: 6417795



### Dimensions

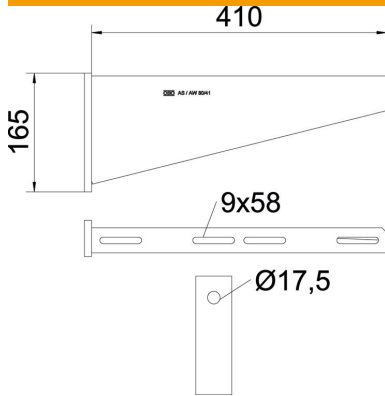

Length	50 mm
Width	410 mm
Height	165 mm
Dimension A	50 mm
Dimension B	410 mm
Dimension H	165 mm

### Technical data

Version for	Wall and support bracket
F in kN	8 kN
Maintain electrical functions	no
Hole diameter	17.5 mm
Rustproof steel, pickled	no
Angle range, max.	90 mm
Angle range, min.	90 mm

### Loads

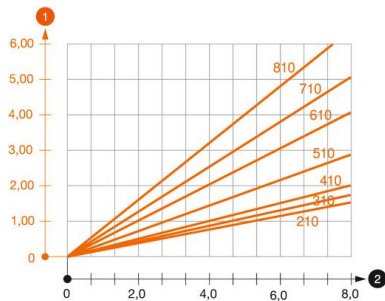

#### Load diagram, bracket, type AW 80

- 1 Bending of the bracket tip at permitted bracket load
- 2 Permitted bracket load in kN without man load
- Load curve with bracket lengths in mm

### Characteristic anchor load values for wall bracket AW 80

Anchor type	Max. load [kN]						
	Bracket width [mm]						
BZ3 16x135/0-35	210	310	410	510	610	710	810
	7.31	7.66	6.87	6.38	5.90	5.17	4.69

Max. total load F = cable weight + cable tray + bracket. The load capacity values increase considerably when used in uncracked concrete. The values given are based on concrete of strength class C20/25. Observe the installation conditions of the DIBt approval (anchors).