

Technical data sheet

Wall bracket AW 80

Item number: 6417833



Heavy-duty wall bracket with welded head plate.
When fastening cable trays and ladders with truss-head bolts of size M6, please order large washers separately (perforation in bracket 9 x ...).



St Steel

FT Hot-dip galvanised

Master data

Item number	6417833
Type	AW 80 61 FT
Description 1	Wall bracket
Description 2	with welded head plate
Manufacturer	OBO
Dimension	B610mm
Material	Steel
Surface	Hot-dip galvanised
Surface standard	DIN EN ISO 1461
Smallest sales unit	1
Unit of quantity	Piece
Weight	433 kg
Weight unit	kg/100 pc.

Technical data sheet

Wall bracket AW 80

Item number: 6417833



Dimensions

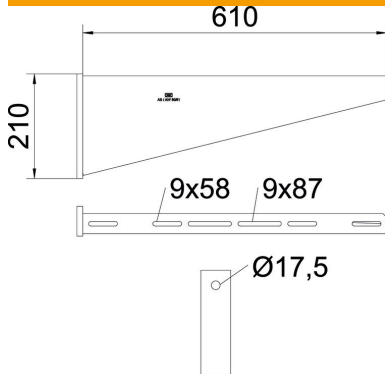

Length	610 mm
Width	610 mm
Height	210 mm
Dimension A	60 mm
Dimension B	610 mm
Dimension H	210 mm

Technical data

Version for	Wall and support bracket
F in kN	8 kN
Maintain electrical functions	no
Hole diameter	17.5 mm
Rustproof steel, pickled	no
Angle range, max.	90 mm
Angle range, min.	90 mm

Loads

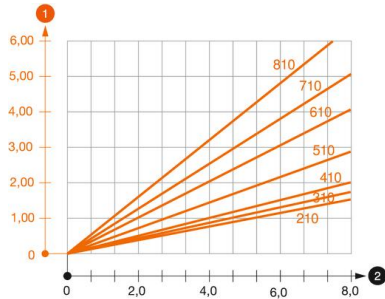

Load diagram, bracket, type AW 80

- 1 Bending of the bracket tip at permitted bracket load
- 2 Permitted bracket load in kN without man load
- Load curve with bracket lengths in mm

Characteristic anchor load values for wall bracket AW 80

Anchor type	Wall fastening						
	Max. load [kN]						
	Bracket width [mm]						
	210	310	410	510	610	710	810
BZ3 16x135/0-35	7.31	7.66	6.87	6.38	5.90	5.17	4.69

Max. total load F = cable weight + cable tray + bracket. The load capacity values increase considerably when used in uncracked concrete. The values given are based on concrete of strength class C20/25. Observe the installation conditions of the DIBt approval (anchors).