

Technical data sheet

Chequer plate cover DBKR DD

Item number: 6049141



Chequer plate cover for the walkable cable tray system, type BKR.

The cover thickness is comprised of 2.0 mm of strip-galvanised sheet steel and a 1.3 mm chequer height.

Pre-marked break-out openings at a spacing of 100 mm allow reinstallation of a turn buckle.

When using covers outdoors, additional measures against the influence of wind must be taken.



St Steel

DD Strip galvanised zinc/aluminium, Double Dip

Master data

Item number	6049141
Type	DBKR 200 DD
Description 1	Corrugated steel cover
Description 2	for walkable cable trays
Manufacturer	OBO
Dimension	200x3000
Material	Steel
Surface	Strip galvanised zinc/aluminium, Double Dip
Surface standard	DIN EN 10346
Smallest sales unit	3
Unit of quantity	Metre
Weight	352.066 kg
Weight unit	kg/100 m

Technical data sheet

Chequer plate cover DBKR DD

Item number: 6049141



Dimensions

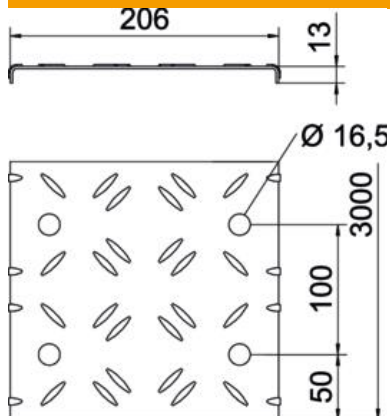

Length	3,000 mm
Width	200 mm
Height	13 mm
Plate thickness	3.3 mm
Dimension B	200 mm
Dimension b	50 mm
Dimension L	3,000 mm

Technical data

Number of turn buckles	0 St.
Fastening type	On top
Maintain electrical functions	no
Suitable for mesh cable tray	no
Suitable for cable ladder	no
Suitable for cable tray	yes
Rustproof steel, pickled	no
Permitted temperature range, max.	60 °C
Permitted temperature range, min.	-5 °C