

Technical data sheet

Cover for 90° bend BKRS FS



Item number: 6049376

Cover for 90° bend with pre-mounted turn buckles.
The cover can be used with fittings of all side heights.



- St** Steel
- FS** Strip galvanized

Master data

Item number	6049376
Type	DFB90 BKR 300 FS
Description 1	Cover for 90° bend
Description 2	walkable
Manufacturer	OBO
Dimension	B300mm
Material	Steel
Surface	Strip galvanized
Surface standard	DIN EN 10346
Smallest sales unit	1
Unit of quantity	Piece
Weight	159.6 kg
Weight unit	kg/100 pc.

Technical data sheet

Cover for 90° bend BKRS FS

Item number: 6049376

Dimensions

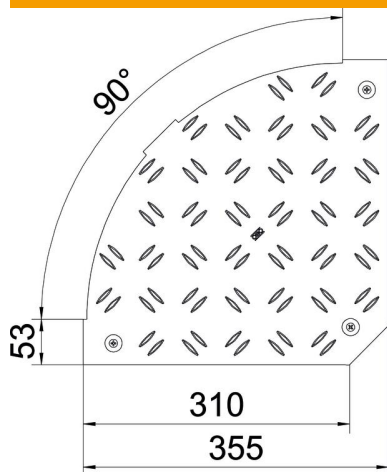

Length	355 mm
Width	355 mm
Height	17 mm
Plate thickness	2 mm
Dimension B	300 mm

Technical data

Bend (angle)	90°
Number of turn buckles	3 St.
Fastening type	Sash lock
Maintain electrical functions	no
Suitable for mesh cable tray	no
Suitable for cable ladder	no
Suitable for cable tray	yes
Change of direction	Horizontal
Rustproof steel, pickled	no
Hinged	no