

Technical data sheet

Cover for 45° Magic bend DD

Item number: 7138404



Cover for 45° bend with pre-mounted turn buckles.
The cover can be used with fittings of all side heights.



St Steel

DD Strip galvanised zinc/aluminium, Double Dip

Master data

Item number	7138404
Type	DFBM 45 200 DD
Description 1	45° bend cover
Description 2	for bend RBM 45 200
Manufacturer	OBO
Dimension	B=200mm
Material	Steel
Surface	Strip galvanised zinc/aluminium, Double Dip
Surface standard	DIN EN 10346
Smallest sales unit	1
Unit of quantity	Piece
Weight	31.4 kg
Weight unit	kg/100 pc.

Technical data sheet

Cover for 45° Magic bend DD

Item number: 7138404



Dimensions

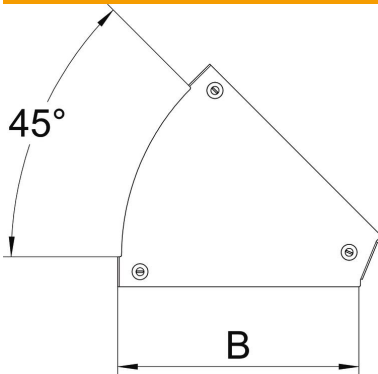

Width	200 mm
Width	8 in
Plate thickness	0.05 in
Plate thickness	1.25 mm
Dimension B	200 mm

Technical data

Bend (angle)	45°
Fastening type	Sash lock
Maintain electrical functions	no
Suitable for mesh cable tray	no
Suitable for cable ladder	no
Suitable for cable tray	yes
Change of direction	Horizontal
Rustproof steel, pickled	no
Hinged	no