

Technical data sheet

Cover for 45° bend DD

Item number: 7131844



Cover for 45° bend with pre-mounted turn buckle.
The cover can be used with fittings of all side heights.



St Steel

DD Strip galvanised zinc/aluminium, Double Dip

Master data

Item number	7131844
Type	DFB 45 200 DD
Description 1	45° bend cover
Description 2	with sash locks, RB 45 200
Manufacturer	OBO
Dimension	B200mm
Material	Steel
Surface	Strip galvanised zinc/aluminium, Double Dip
Surface standard	DIN EN 10346
Smallest sales unit	1
Unit of quantity	Piece
Weight	36.9 kg
Weight unit	kg/100 pc.

Dimensions

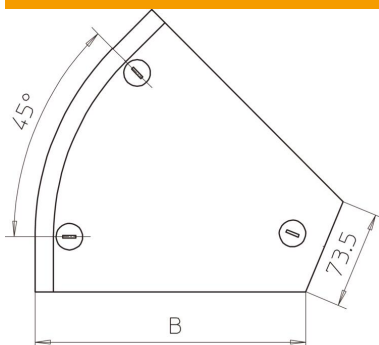

Width	200 mm
Width	8 in
Height	35 mm
Plate thickness	0.04 in
Plate thickness	1 mm
Dimension B	200 mm
Dimension H	15 mm

Technical data sheet

Cover for 45° bend DD

Item number: 7131844



Technical data

Bend (angle)	45°
Number of turn buckles	3 St.
Fastening type	Sash lock
Maintain electrical functions	no
Suitable for mesh cable tray	no
Suitable for cable ladder	yes
Suitable for cable tray	yes
Change of direction	Horizontal
Rustproof steel, pickled	no
Hinged	no