

Technical data sheet

Cover for 90° bend FS

Item number: 7129610



Cover for 90° bend with pre-mounted turn buckles.
The cover can be used with fittings of all side heights.

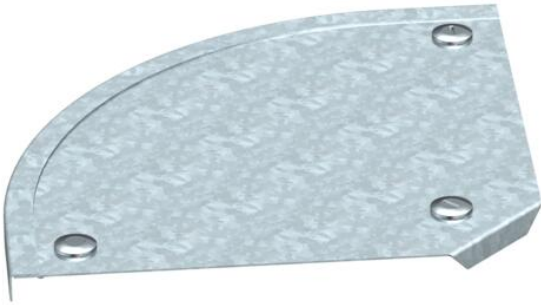

- St** Steel
- FS** Strip galvanized

Master data

Item number	7129610
Type	DFB 90 100 FS
Description 1	90° bend cover
Description 2	with turn-buckles, RB 90 100
Manufacturer	OBO
Dimension	B100mm
Material	Steel
Surface	Strip galvanized
Surface standard	DIN EN 10346
Smallest sales unit	1
Unit of quantity	Piece
Weight	27 kg
Weight unit	kg/100 pc.

Technical data sheet

Cover for 90° bend FS

Item number: 7129610



Dimensions

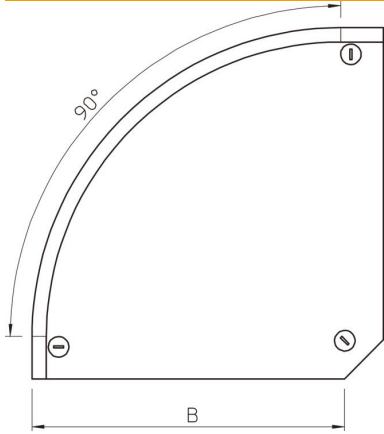

Width	100 mm
Width	4 in
Height	35 mm
Plate thickness	0.04 in
Plate thickness	1 mm
Dimension B	100 mm
Dimension H	15 mm

Technical data

Bend (angle)	90°
Number of turn buckles	3 St.
Fastening type	Sash lock
Maintain electrical functions	no
Suitable for mesh cable tray	no
Suitable for cable ladder	yes
Suitable for cable tray	yes
Change of direction	Horizontal
Rustproof steel, pickled	no
Hinged	no