

Technical data sheet

Heavy-duty mounting lid for 350, nominal size R7

Item number: 7401414



The heavy-duty mounting lid for the UZD350 underfloor box is suitable for the installation of a round heavy-duty cassette of nominal size R7. The installation opening is recessed by 3 mm and can be closed subsequently by a lid blanking plate.
Die Nivelliereinheiten müssen separat bestellt werden.



St Steel

FS Strip galvanized

Master data

Item number	7401414
Type	DUG 350-3 R7SL
Description 1	Heavy-duty mounting lid
Description 2	350-3 for nominal size R7
Manufacturer	OBO
Dimension	382x382x59
Material	Steel
Surface	Strip galvanized
Surface standard	DIN EN 10346
Smallest sales unit	1
Unit of quantity	Piece
Weight	370.4 kg
Weight unit	kg/100 pc.

Technical data sheet

Heavy-duty mounting lid for 350, nominal size R7

Item number: 7401414



Dimensions

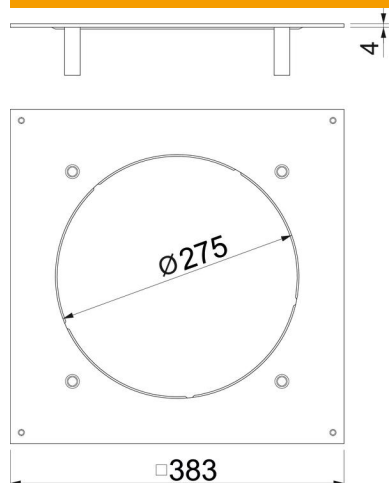

Length	383 mm
Width	383 mm
Dimension A	383 mm
Dimension d Ø	275 mm

Technical data

Mounting opening cover	no
Floor care	Dry
Seal installation option	no
Installation opening for on-floor tank	no
Suitable for screed-flush closed underfloor ducts	no
Suitable for screed-covered underfloor ducts	yes
Material thickness	4 mm
Mounting opening	Round
Nominal size	350 mm
Nominal size for device installation units	R7
Heavy-duty version	yes