

Technical data sheet

Marking spreading tool for drop-in anchors

Item number: 3492966



Marking spreading tool with hand protection for drop-in anchors, type E



CE

St Steel

G Electrogalvanized

Master data

Item number	3492966
Type	E-MSH 8x25
Description 1	Setting tool
Description 2	for Drop-in Anchor E/ES
Manufacturer	OBO
Dimension	8x25
Material	Steel
Surface	Electrogalvanized
Surface standard	EN ISO 19598 / EN ISO 4042
Smallest sales unit	1
Unit of quantity	Piece
Weight	42.5 kg
Weight unit	kg/100 pc.

Technical data sheet

Marking spreading tool for drop-in anchors

Item number: 3492966



Dimensions

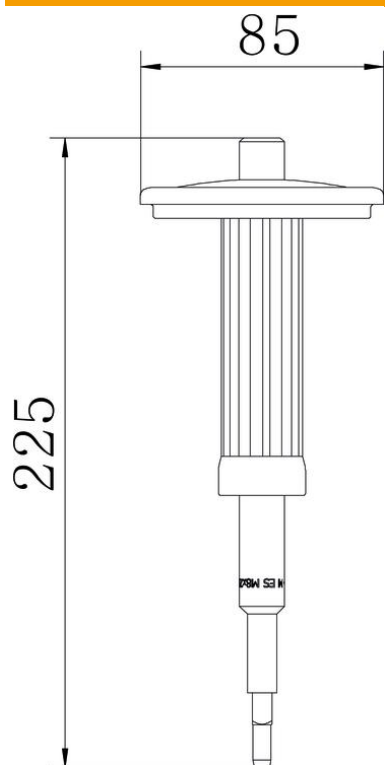

Length	225 mm
--------	--------

Technical data

Thread	M8
With hand protection	yes
Pin dimension	8 mm