

# Technical data sheet

External corner, asymmetrical, for device installation trunking Rapid 80 type GS-A90130  
Item number: 6277510



External corner for changing the direction of the GS device installation trunking.



St Steel

## Master data

Item number	6277510
Type	GS-AA90130RW
Description 1	External corner
Description 2	asymmetrical
Manufacturer	OBO
Dimension	90x130x300
Colour	Pure white; RAL 9010
Material	Steel
Smallest sales unit	1
Unit of quantity	Piece
Weight	221 kg
Weight unit	kg/100 pc.

# Technical data sheet

External corner, asymmetrical, for device installation trunking Rapid 80 type GS-A90130

Item number: 6277510



## Dimensions



Length	300 mm
Width	130 mm
Height	90 mm

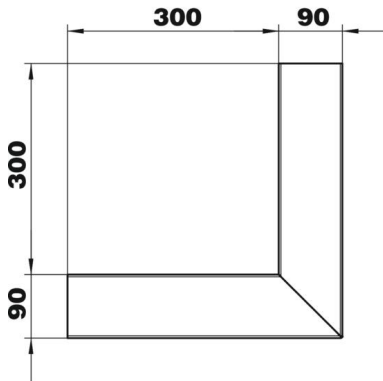

## Technical data

Number of covers	1
Version for	Base
for duct width	130 mm
for trunking height	90 mm
Halogen-free	yes
Cable retaining clip	no
Duct connector	no
Cover mounting type	Internal
Mounting perforation in base	yes
Cover width	76.5 mm
Protection rating	IP30
Protective film	yes
Protection rating IK code	IK10
Symmetrical	no
Permitted temperature range, max.	60 °C
Permitted temperature range, min.	-25 °C
Angle range, min.	90 mm