

Technical data sheet

Hexagonal nut DIN 934 V5A

Item number: 3400183



Hexagonal nut to DIN 934 with metric thread.

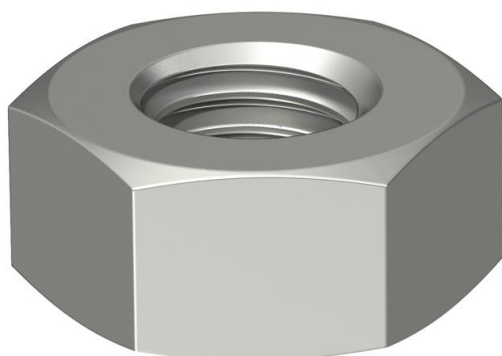

A5 Stainless steel

Master data

Item number	3400183
Type	HN M6 A5
Description 1	Hexagonal nut
Manufacturer	OBO
Dimension	M6
Material	Stainless steel
Smallest sales unit	100
Unit of quantity	Piece
Weight	0.25 kg
Weight unit	kg/100 pc.

Technical data sheet

Hexagonal nut DIN 934 V5A

Item number: 3400183



Dimensions

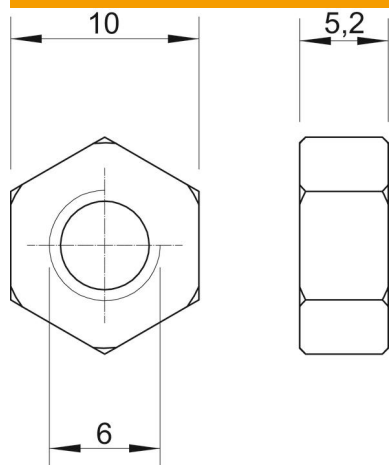

Dimension d	6 mm
Dimension h	5.2 mm

Technical data

Resistance grade	8
Thread	M6
Thread metric	6
Thread type	Metric
Halogen-free	yes
With flange	no
WAF	10
Self-locking	no
Left thread	no
Thread, imperial	1/4"
Nut version	Nut
Screw system nut	Hexagon head