

Technical data sheet

Cable tray MKS-Magic® 110

Item no. 6059166

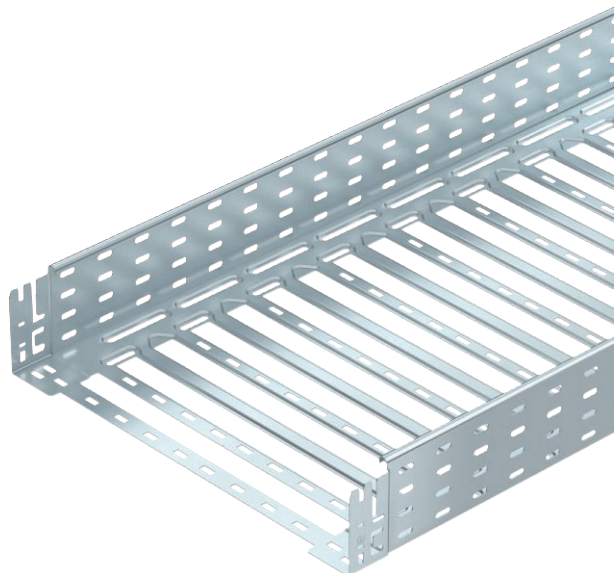

Cable tray with integrated quick fastening system. The usable length of the cable tray is 3,000 mm.
 The cable tray has continuous side perforations of 7 x 20 mm for the installation of additional connection and mounting components.
 From a cable tray width of 200 mm with 30% hole surface, suitable for use under sprinkler systems according to VdS guideline 2092.
 Continuous equipotential bonding is guaranteed without additional components.



- St** Steel
- FS** Strip galvanised

Master data

Item no.	6059166
Type	MKSM 150 FS
Description 1	Cable tray MKSM
Description 2	perforated, quick connector
Manufacturer	OBO
Dimension	110x500x3050
Material	Steel
Material symbol	St
Surface	Strip galvanised
Surface to DIN	DIN EN 10346
Surface symbol	FS
Smallest sales unit (VG)	3 m
Weight	406,98 kg/100 m

Technical data



Usable cross-section	54.800,00 mm ²
Usable cross-section	548,00 cm ²
Suitable for maintaining electrical function	<input type="checkbox"/>
Connector version	Integrated connector
With cover	<input type="checkbox"/>
Mounting perforation in base	<input checked="" type="checkbox"/>
NATO hole pattern	<input type="checkbox"/>
Rustproof steel, pickled	<input type="checkbox"/>
Side perforation	<input checked="" type="checkbox"/>
Wide-span version	<input type="checkbox"/>

Technical data sheet

Cable tray MKS-Magic® 110

Item no. 6059166



Technical data

Dimensions

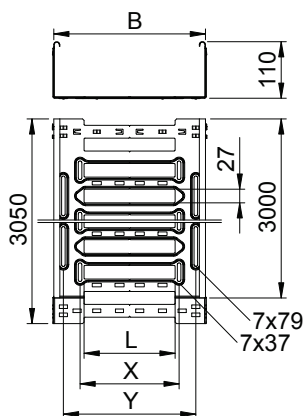

Length	3.050,00 mm
Width	500,00 mm
Height	110,00 mm
Side height	110,00 mm
Dimension B	500,00 mm
Dimension L	380,00 mm
Dimension x	396,00 mm
Dimension y	462,00 mm
Plate thickness	1,00 mm

Appr. load:

Support spacing 1.5 m	1,80 kN/m
Support spacing 2.0 m	1,30 kN/m
Support spacing 2.5 m	0,92 kN/m
Support spacing 3.0 m	0,65 kN/m

Load diagram, cable tray, type MKSM 110

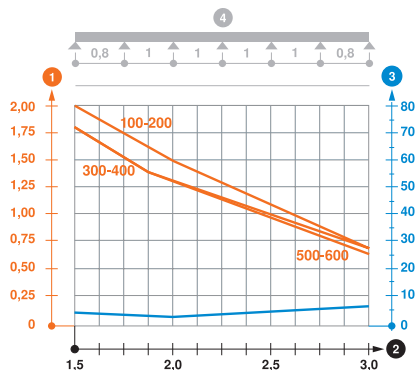

- 1 Permitted cable tray/ladder load in kN/m without man load
- 2 Support width in m
- 3 Rail bend in mm at permitted kN/m
- 4 Load scheme during testing
- Load curve with cable tray/ladder width in mm
- Strut bend curve according to support width