

Technical data sheet

Cable tray SKS-Magic® 110, unperforated

Item no. 6059863

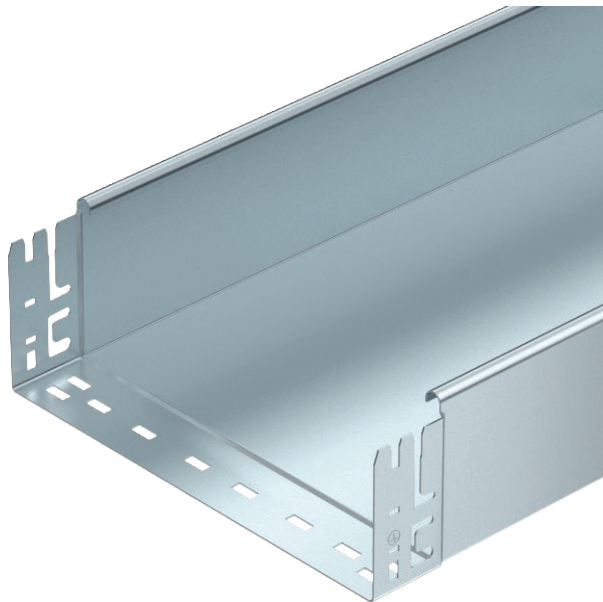

Unperforated cable tray with integrated quick fastening system. The usable length of the cable tray is 3,000 mm.

Continuous equipotential bonding is guaranteed without additional components.



- St** Steel
- FT** Hot-dip galvanised

Master data

Item no.	6059863
Type	SKSMU 150 FT
Description 1	Cable tray SKSMU
Description 2	unperforated, quick connector
Manufacturer	OBO
Dimension	110x500x3050
Material	Steel
Material symbol	St
Surface	Hot-dip galvanised
Surface to DIN	DIN EN ISO 1461
Surface symbol	FT
Smallest sales unit (VG)	3 m
Weight	932,69 kg/100 m

Technical data

	Usable cross-section	54.800,00 mm ²
	Usable cross-section	548,00 cm ²
	Suitable for maintaining electrical function	<input type="checkbox"/>
	Connector version	Integrated connector
	With cover	<input type="checkbox"/>
	Mounting perforation in base	<input type="checkbox"/>
	NATO hole pattern	<input type="checkbox"/>
	Rustproof steel, pickled	<input type="checkbox"/>
	Side perforation	<input type="checkbox"/>
	Wide-span version	<input type="checkbox"/>

Technical data sheet

Cable tray SKS-Magic® 110, unperforated

Item no. 6059863



Technical data

Dimensions

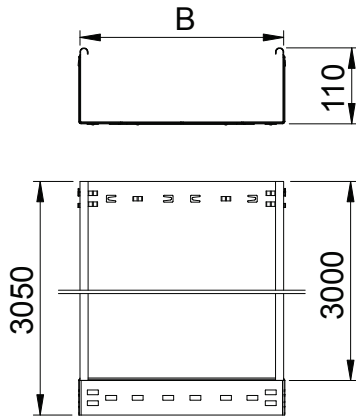

Length	3.050,00 mm
Width	500,00 mm
Height	110,00 mm
Side height	110,00 mm
Dimension B	500,00 mm
Plate thickness	1,50 mm

Appr. load:

Support spacing 1.5 m	3,00 kN/m
Support spacing 2.0 m	2,40 kN/m
Support spacing 2.5 m	1,76 kN/m
Support spacing 3.0 m	1,20 kN/m
Support spacing 3.5 m	0,84 kN/m
Support spacing 4.0 m	0,80 kN/m

Load diagram, cable tray, type SKSMU 110

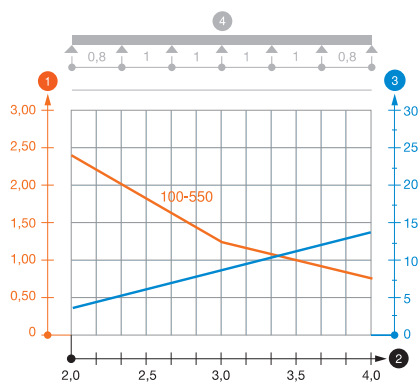

- 1 Permitted cable tray/ladder load in kN/m without man load
- 2 Support width in m
- 3 Rail bend in mm at permitted kN/m
- 4 Load scheme during testing
- Load curve with cable tray/ladder width in mm
- Strut bend curve according to support width