

Technical data sheet

Cable tray SKS-Magic® 60

Item no. 6059515

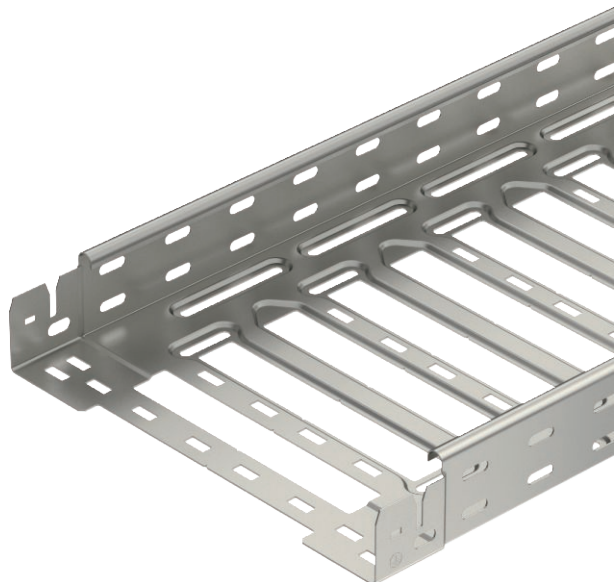

Cable tray with integrated quick fastening system. The usable length of the cable tray is 3,000 mm.

The cable tray has continuous side perforations of 7 x 20 mm for the installation of additional connection and mounting components.

From a cable tray width of 200 mm with 30% hole surface, suitable for use under sprinkler systems according to VdS guideline 2092.

Continuous equipotential bonding is guaranteed without additional components.



VA Stainless steel, rustproof 1.4571

2B Bright, reworked

Master data

Item no.	6059515
Type	SKSM 640 A4
Description 1	Cable tray SKSM
Description 2	perforated, quick connector
Manufacturer	OBO
Dimension	60x400x3050
Material	Stainless steel, material no. 1.4571
Material symbol	A4
Surface	Bright, reworked
Surface symbol	2B
Smallest sales unit (VG)	3 m
Weight	451,33 kg/100 m

Technical data

	Usable cross-section	23.800,00 mm ²
	Usable cross-section	238,00 cm ²
	Suitable for maintaining electrical function	<input type="checkbox"/>
	Connector version	Integrated connector
	With cover	<input type="checkbox"/>
	Mounting perforation in base	<input checked="" type="checkbox"/>
	NATO hole pattern	<input type="checkbox"/>
	Rustproof steel, pickled	<input type="checkbox"/>
	Side perforation	<input checked="" type="checkbox"/>
	Wide-span version	<input type="checkbox"/>

Technical data sheet

Cable tray SKS-Magic® 60

Item no. 6059515



Technical data

Dimensions

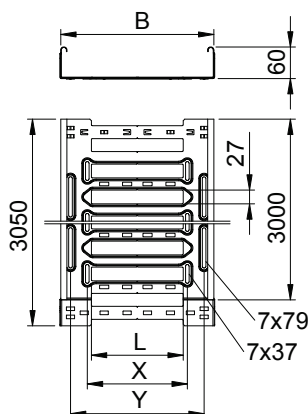

Length	3.050,00 mm
Width	400,00 mm
Height	60,00 mm
Side height	60,00 mm
Dimension B	400,00 mm
Dimension L	280,00 mm
Dimension x	296,00 mm
Dimension y	362,00 mm
Plate thickness	1,50 mm

Appr. load:

Support spacing 1.5 m	2,70 kN/m
Support spacing 2.0 m	2,10 kN/m
Support spacing 2.5 m	1,47 kN/m
Support spacing 3.0 m	0,80 kN/m

Load diagram, cable tray, type SKSM 60

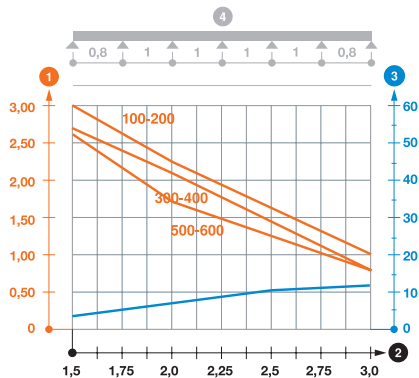

- 1 Permitted cable tray/ladder load in kN/m without man load
- 2 Support width in m
- 3 Rail bend in mm at permitted kN/m
- 4 Load scheme during testing
- Load curve with cable tray/ladder width in mm
- Strut bend curve according to support width