

Technical data sheet

Cover for add-on tee A4

Item number: 6226381



Cover with turn buckles for covering add-on tees with welded rungs.



A4 Stainless steel

2B Bright, treated

Master data

Item number	6226381
Type	LAAD 200 R3 A4
Description 1	Cover for add-on tee
Description 2	with turn buckle
Manufacturer	OBO
Dimension	B200
Material	Stainless steel
Surface	Bright, treated
Surface standard	
Smallest sales unit	1
Unit of quantity	Piece
Weight	180 kg
Weight unit	kg/100 pc.

Technical data sheet

Cover for add-on tee A4

Item number: 6226381



Dimensions

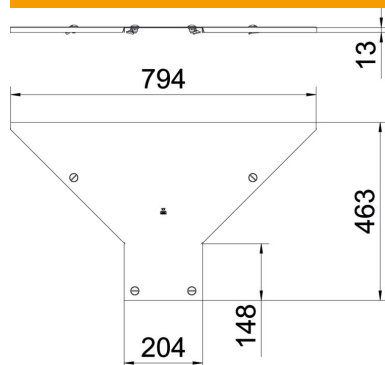

Width	200 mm
Plate thickness	1 mm
Dimension B	200 mm

Technical data

Fastening type	Sash lock
Suitable for cable ladder	yes
Suitable for cable tray	no
Material thickness	1 mm
Rustproof steel, pickled	no
Permitted temperature range, max.	120 °C
Permitted temperature range, min.	-20 °C
Wide-span version	no