

Technical data sheet

Cover for add-on tee FT

Item number: 6226336



Cover with turn buckles for covering add-on tee with welded rungs.



CE

St Steel

FT Hot-dip galvanised

Master data

Item number	6226336
Type	LAAD 450 R3 FT
Description 1	Cover for add-on tee
Description 2	with turn buckle
Manufacturer	OBO
Dimension	B450
Material	Steel
Surface	Hot-dip galvanised
Surface standard	DIN EN ISO 1461
Smallest sales unit	1
Unit of quantity	Piece
Weight	341 kg
Weight unit	kg/100 pc.

Technical data sheet

Cover for add-on tee FT

Item number: 6226336



Dimensions

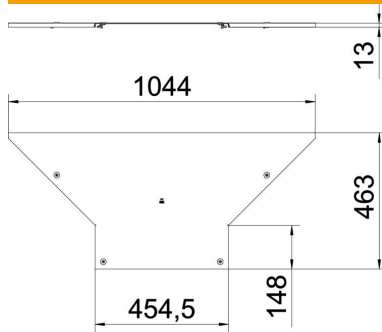

Width	450 mm
Plate thickness	1.25 mm
Dimension B	450 mm

Technical data

Fastening type	Sash lock
Suitable for cable ladder	yes
Suitable for cable tray	no
Material thickness	1.25 mm
Rustproof steel, pickled	no
Wide-span version	no