

Technical data sheet

Cover for add-on tee A2

Item number: 6226367



Cover with turn buckles for covering add-on tees with welded rungs.



A2 Stainless steel

2B Bright, treated

Master data

Item number	6226367
Type	LAAD 500 R3 A2
Description 1	Cover for add-on tee
Description 2	with turn buckle
Manufacturer	OBO
Dimension	B500
Material	Stainless steel
Surface	Bright, treated
Surface standard	
Smallest sales unit	1
Unit of quantity	Piece
Weight	365 kg
Weight unit	kg/100 pc.

Technical data sheet

Cover for add-on tee A2

Item number: 6226367



Dimensions

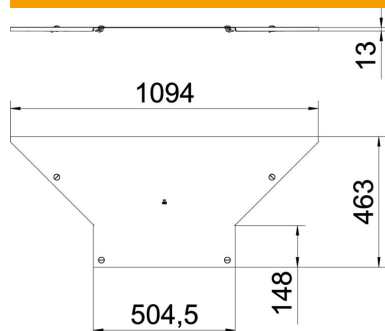

Width	500 mm
Plate thickness	1.25 mm
Dimension B	500 mm

Technical data

Fastening type	Sash lock
Suitable for cable ladder	yes
Suitable for cable tray	no
Material thickness	1.25 mm
Rustproof steel, pickled	no
Permitted temperature range, max.	120 °C
Permitted temperature range, min.	-20 °C
Wide-span version	no