

Technical data sheet

Cable ladder LG 60, 3 m VS FS

Item number: 6208547



Cable ladder with perforated side rail of side height 60 mm with riveted C profile frames, open in an upwards direction (VS version).
The cable ladder is shipped folded up.

Cables can be mounted with the matching clamp clip, type 2056.

The cable ladders in the widths 200 mm to 400 mm are also approved for vertical mounting as a vertical ladder in systems that guarantee the maintenance of electrical functionality according to DIN 4102 Part 12. Cables can be mounted with the clamp clip approved for maintenance of electrical function, type 2056 M. Magnetic shield insulation without cover 10 dB, with cover 15 dB. Additional widths are available on request.



St Steel

FS Strip galvanized

Master data

Item number	6208547
Type	LG 650 VS 3 FS
Description 1	Cable ladder
Description 2	perforated, with VS rung
Manufacturer	OBO
Dimension	60x500x3000
Material	Steel
Surface	Strip galvanized
Surface standard	DIN EN 10346
Smallest sales unit	3
Unit of quantity	Metre
Weight	332.6 kg
Weight unit	kg/100 m

Technical data sheet

Cable ladder LG 60, 3 m VS FS

Item number: 6208547



Dimensions

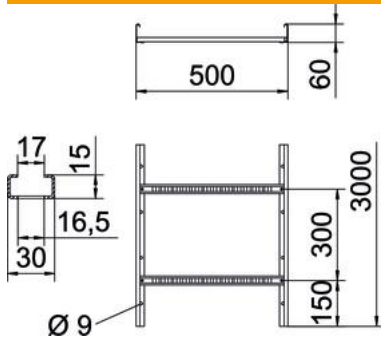

Dimension	60x500x3000
Length	3,000 mm
Length	3,000 ft
Width	500 mm
Height	60 mm
Dimension B	500 mm
Rung slot dimension	16.50

Technical data

Version of the rungs	Profile perforated
Side rail version	Flat profile
Fastening of rung	Blind riveted
Maintain electrical functions	no
Usable cross-section	248 cm ²
Usable cross-section	24800 mm ²
Rustproof steel, pickled	no
Side perforation	yes
Rung distance	300 mm
Wide-span version	no
Rail thickness	1.5 mm

Loads

Insertable support spacings, min.	1.5 m
Insertable support spacings, max.	4 m
Support spacing 1.5 m	3.1 kN/m
Support spacing 2.0 m	2.25 kN/m
Support spacing 2.5 m	1.5 kN/m
Support spacing 3.0 m	1.1 kN/m
Support spacing 3.5 m	0.75 kN/m
Support spacing 4.0 m	0.45 kN/m

Load diagram, cable ladder, type LG 60 VS

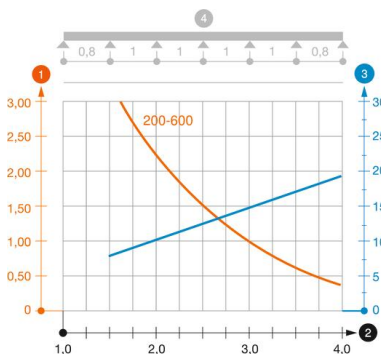

- 1 Permitted cable tray/ladder load in kN/m without man load
- 2 Support width in m
- 3 Rail bend in mm at permitted kN/m
- 4 Load scheme during testing
- Load curve with cable tray/ladder width in mm
- Strut bend curve according to support width