

Technical data sheet

Cover for tee FT

Item number: 6226120



Cover with turn buckles for covering T pieces with welded rungs.



St Steel

FT Hot-dip galvanised

Master data

Item number	6226120
Type	LTD 200 R3 FT
Description 1	Cover for T piece
Description 2	with turn buckle
Manufacturer	OBO
Dimension	B200
Material	Steel
Surface	Hot-dip galvanised
Surface standard	DIN EN ISO 1461
Smallest sales unit	1
Unit of quantity	Piece
Weight	298 kg
Weight unit	kg/100 pc.

Technical data sheet

Cover for tee FT

Item number: 6226120



Dimensions

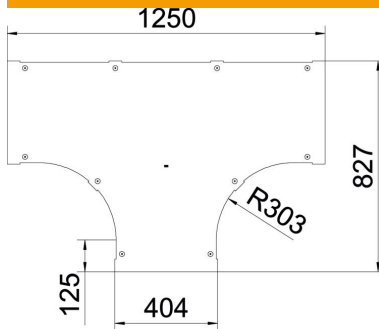

Width	200 mm
Plate thickness	1 mm
Dimension B	200 mm

Technical data

Fastening type	Sash lock
Suitable for cable ladder	yes
Suitable for cable tray	no
Material thickness	1 mm
Rustproof steel, pickled	no
Wide-span version	no