

Technical data sheet

Lock washer

Item number: 3405087



Lock washer M8

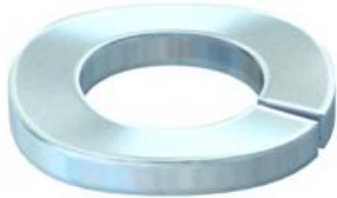

St Steel

G Electrogalvanized

Master data

Item number	3405087
Type	LWS M8 G
Description 1	Lock washer
Manufacturer	OBO
Dimension	M8
Material	Steel
Surface	Electrogalvanized
Surface standard	EN ISO 19598 / EN ISO 4042
Smallest sales unit	100
Unit of quantity	Piece
Weight	0.13 kg
Weight unit	kg/100 pc.

Dimensions

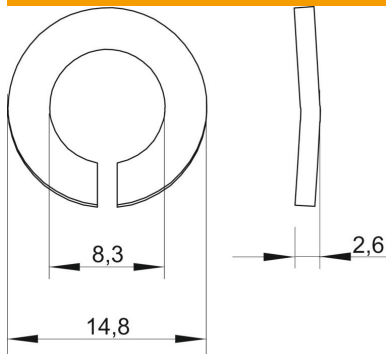

Height	2.6 mm
Plate thickness	0.1 in
Dimension D	0.58 in
Dimension d	0.33 in
Dimension d	8.3 mm
Dimension d max.	14.8 mm
Dimension d min.	14.8 mm
Dimension h	2.6 mm

Technical data

Thread	M8
Inner diameter	0.33 mm
Lock washer version	Ribbed

Technical data sheet

Lock washer

Item number: 3405087

