

Technical data sheet

Centre suspension, universal FS

Item number: 6358860



Universal centre suspension for fastening to threaded rods and supports.
Preferred use of this centre suspension in combination with cable ladders and mesh cable trays.



St Steel

FS Strip galvanized

Master data

Item number	6358860
Type	MAHU 400 FS
Description 1	Centre suspension
Description 2	universal
Manufacturer	OBO
Dimension	B400mm
Material	Steel
Surface	Strip galvanized
Surface standard	DIN EN 10346
Smallest sales unit	1
Unit of quantity	Piece
Weight	68.8 kg
Weight unit	kg/100 pc.

Technical data sheet

Centre suspension, universal FS

Item number: 6358860



Dimensions

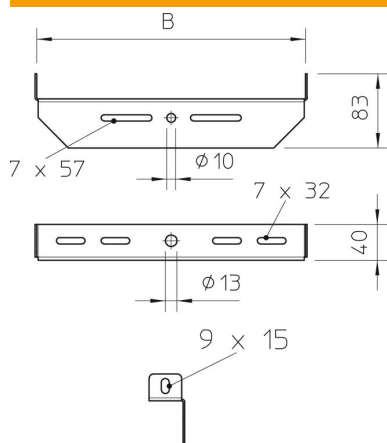

Width	400 mm
Dimension B	400 mm

Technical data

Version for	Miscellaneous
Maintain electrical functions	no
Suitable for metric threaded rod	12
Suitable for mesh cable tray	yes
Suitable for cable ladder	yes
Suitable for cable tray	yes
Suitable for tray/ladder width	400 mm
Tray fastening	Screw-on
Adjustable	no